



Thank you for purchasing **KOSO DL-02R tachometer**, before operating the unit, please read the instruction thoroughly and retain it for the future reference.

⚠ Notice

1. **DC 12V** applications only.
2. For installation, please follow the steps described in manual. Any damage caused by wrong installation shall be imputed to the users.
3. To avoid the short circuit, please don't pull the wire when installing. Don't break or modify the wire terminal.
4. Do not disassemble or change any parts excluding the manual description.
5. The interior examination or maintenance should be executed by our professionals.

MARK MEANING:

NOTE You could get the installation details from the information behind the mark.

⚠ Some processes must be followed to avoid the affection caused by wrong installation.

WARNING! Some processes must be followed to avoid damages to yourself or the public.

CAUTION! Some processes must be followed to avoid the damage to the vehicle.



PRESS THE
BUTTON ONE TIME



PRESS THE
BUTTON 3
SECONDS

1-1 Accessory

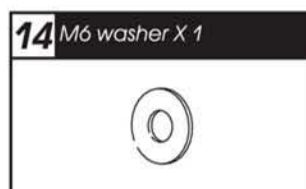
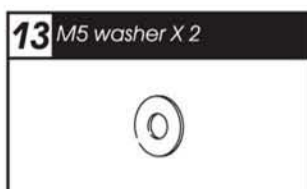
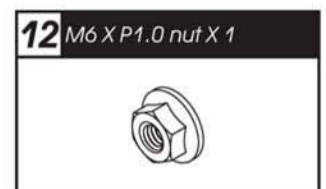
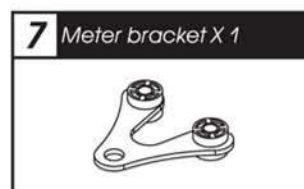
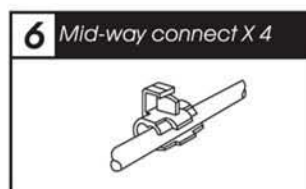
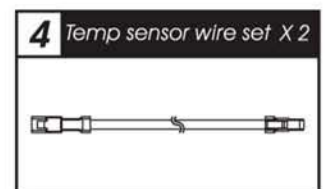
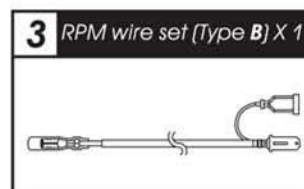
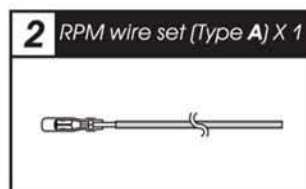
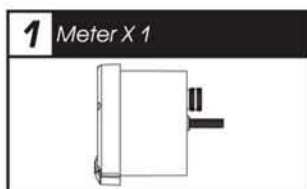

NOTE Please contact the local distributor if the items you open are not the same, with the above-listed one.

1-2 Option accessory

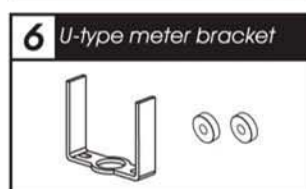
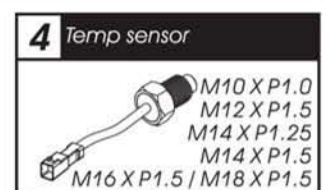
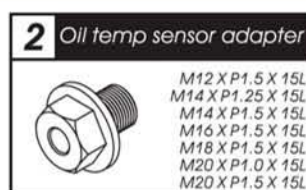
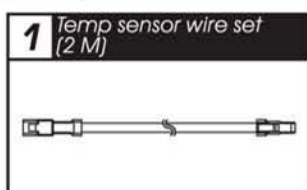

NOTE Some of the option accessories may not sell. For the details, please contact the local distributor.

2-1 Wiring installation instructions

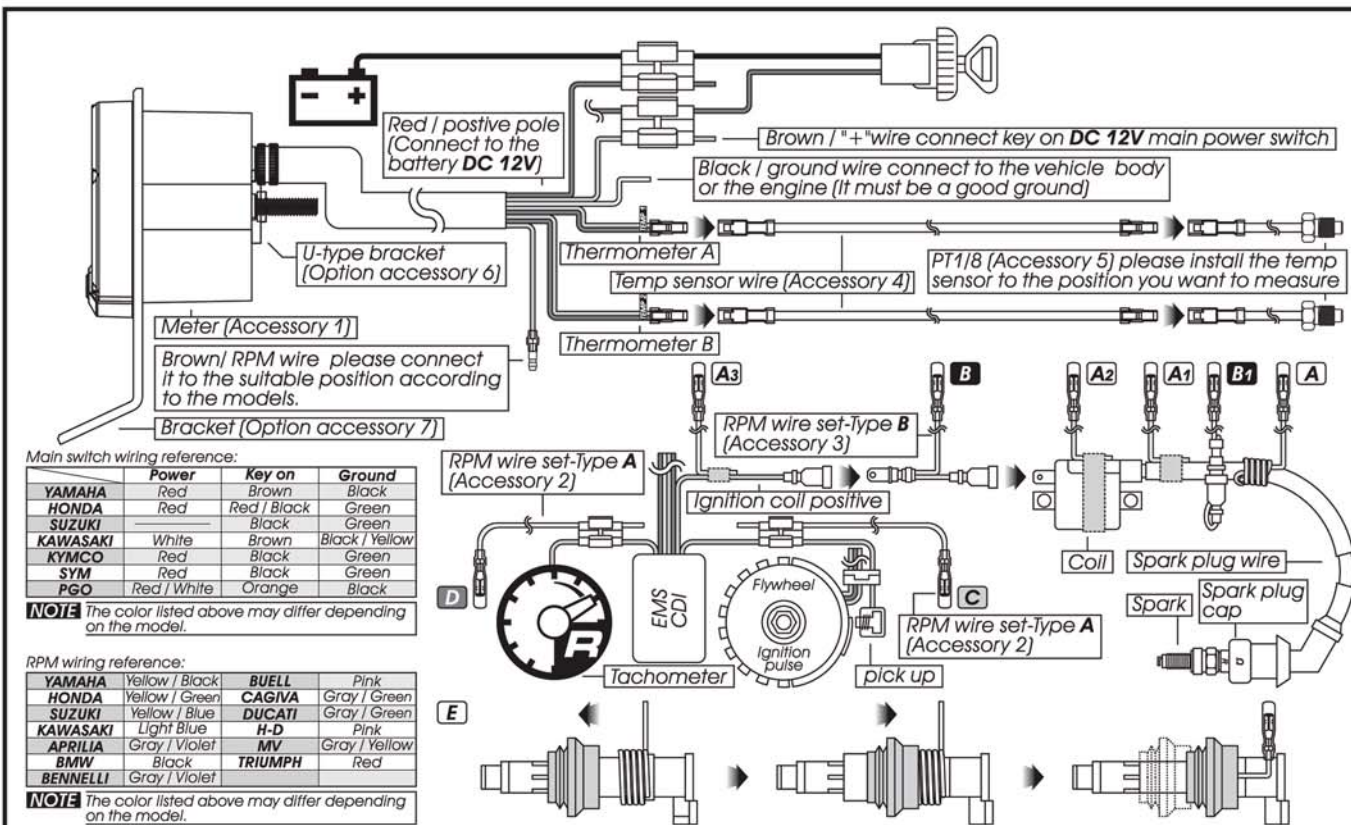

NOTE The temperature will disappear if you don't install & connect the temperature sensor with the meter.

NOTE When connecting the power wiring, please follow the instruction. If you connect the red & brown wiring in parallel will cause the meter work improperly.

⚠ The RPM wire installation

- A. Please wrap the RPM wire at least 5 times around the spark plug.
- A1. Please use tape to fix the RPM (Type A) wire onto the spark plug wire.
- A2. Please use tape to fix the RPM wire (Type A) on the spark plug cap.
- A3. Please use tape to fix the RPM wire (Type A) on the coil positive pole wire. For some pole models with the coil negative wire, please tape the RPM wire (Type A) on the negative wire to get the RPM signal. (For example, the YAMAHA V-max 1200)
- B. Please connect the RPM wire (type B) to connect to the ignition coil positive pole.
- B1. Please wrap the RPM wire (type B) on the spark plug wire by connecting the male and female connector.
- C. Please connect the RPM wire (Type A) to the pick up.
- D. Please parallel the RPM wire (Type A) with the original tachometer signal wire (This method is available only when the original speedometer comes with a tachometer on it. You could get the RPM wire information from the service manual of your bikes.)
- E. For the models comes with the new Ignition coil, please wrap the RPM wire (Type A) at least 5 times around the spark plug as the above drawing.

For multi-ignition models, we will suggest you to get the signal on the first ignition.

The best signal source will be in order as D>C>B>A, we will suggest you to check different ways if you have problems to get the RPM signal.

2-2 Installation instructions

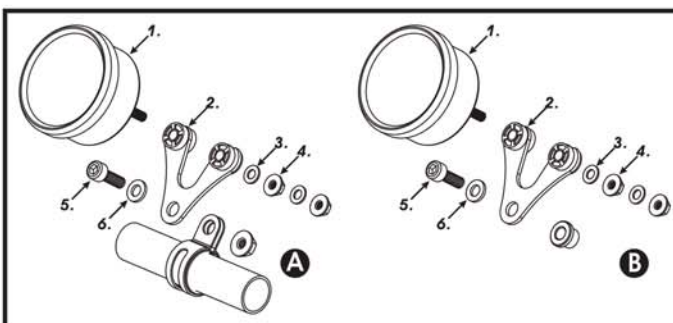

When installing, please follow the process.

1. Load meter (Accessory 1)
2. Meter bracket (Accessory 7)
3. M5 washer X 2 (Accessory 13)
4. M5 X P0.8 nut X 2 (Accessory 11)
5. M6 X P1.0 screw (Accessory 10)
6. M6 washer (Accessory 14)
- A Use the meter bracket (Accessory 7), handle bar clamp (Accessory 8), rubber (Accessory 9) and the nut to install the speedometer on the handle bar.
- B Use the aluminum bush (Accessory 15) to install the speedometer on the handle bar stem.

3-1A Overview

Bar graph tachometer

- Display range: 0~10,000 / 15,000 / 20,000 RPM.

Digital tachometer

- Display range: 0~20,000 RPM.
- Display unit: 100 RPM.

Digital thermometer A

- Display range: 0~250°C (32~482°F)
- Display unit: 1°C (1°F), °C & °F for alternative.



Thermometer A.B

- Display range: 0~250°C (32~482°F)
- Display unit: 0.1°C (0.1°F), °C & °F for alternative.

Clock

- 24 H.

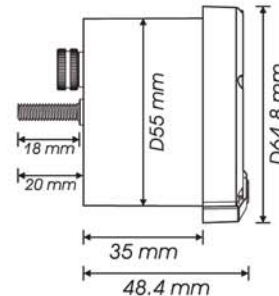
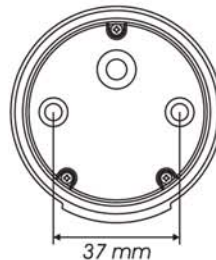

Clockwise

3-1B Overview

Anticlockwise

Bar graph tachometer
 ● Display range: 0~10,000 / 15,000 / 20,000 RPM.

Digital tachometer
 ● Display range: 0~20,000 RPM.
 ● Display unit: 100 RPM.

Digital thermometer A
 ● Display range: 0~250°C (32~482°F)
 ● Display unit: 1°C (1°F), C & F for alternative.



Thermometer A.B
 ● Display range: 0~250°C (32~482°F)
 ● Display unit: 0.1°C (0.1°F), °C & °F for alternative.
Clock
 ● 24 H.

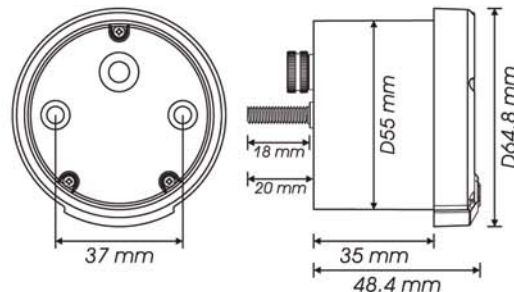

3-2 Function, setting instruction

● Digital Tachometer	Display range: 0~20,000 RPM	○ Display Internal	<0.5 second
● Bar graph tachometer	Display range: 10,000 / 15,000 / 20,000 RPM	○ Top temperature record	Display range: 0~250°C (32~482°F)
○ Display internal	<0.5 second	● Display Internal	24 H
○ Max. RPM record	Display range: 0~20,000 RPM	● Effective voltage	DC 12 V
○ Stroke / piston setting	Setting unit: 0.5, 1, 1.5, 2, 2.5, 3, 4, 5, 6	● Effective temperature range	-10~+60°C
● Thermometer A.B	Display range :0~250°C (32~482°F) Display unit: 0.1°C (0.1°F) °C, °F for alternative	● Meter standard	JIS D 0203
		● Meter size	D55 X 48.4 mm
		● Meter weight	Around 190 g

NOTE Design and specification are subject to change without notice!

NOTE If you enter the setting screen for 30 seconds and don't press the button, it will back to the main screen automatically.

4-1A Select button function instruction

- Press the **Select button** one time to the Max. record screen.
- Press down the **Select button** for 3 seconds to switch the digital tachometer to digital thermometer.
- In Max. record screen, press the **Select button** one time to return to the main screen.
- Press the **Select button** for 3 seconds to reset the Max. Record.

4-1B Adjust button function instruction

- In main screen, press the **Adjust button** one time to switch from temp A to temp B.
- Press down the **Adjust button** for 3 seconds to switch the temperature unit from °C to °F.
- In temp B screen, press the **Adjust button** one time to switch the temp B to the clock.
- In the Clock screen, press the **Adjust button** one time to return to the main screen.

4-2 Cycle / Piston / Input signal / Time setting instruction

- In main screen, press down the **Select & Adjust button** for 3 seconds to enter the setting screen.

- **EX. You want to change the current setting value from 1 to 2.**
- Press the **Adjust button** to enter the corresponding value for the RPM signal number per Ignition. (Please check the reference table below!)
- **EX.** The original setting is 0.5 (4C-1P).

NOTE The piston type can be set is 0.5, 1, 1.5, 2, 2.5, 3, 4, 5, 6.

The setting value	The corresponding stroke and piston number	The corresponding RPM signal number per Ignition
0.5	4C-1P	2 RPM signals per Ignition.
1	2C-1P 4C-2P	1 RPM signal per Ignition.
1.5	4C-3P	
2	2C-2P 4C-4P	1 RPM signal per 2 Ignition.
2.5	4C-5P	
3	2C-3P 4C-6P	1 RPM signal per 3 Ignition.
4	2C-4P 4C-8P	1 RPM signal per 4 Ignition.
5	4C-10P	1 RPM signal per 5 Ignition.
6	2C-6P 4C-12P	1 RPM signal per 6 Ignition.

CAUTION!

Most of the 4-cycle bikes with one single piston are Igniting every 360 degree once, so the setting should be the same as the bike with 2-cycle and one piston engine.



- Press the **Select** button to enter the RPM signal input setting.
- EX. The Ignition angle setting is changed from 1 to 2 (4C-4P).



- EX. We would like to change the setting to Lo. (The negative impulse)
- Press the **Adjust** button to choose the input signal you want to set.
- EX. Now the setting is HI (The positive impulse)

NOTE The Impulse setting range is between HI (the positive impulse)& Lo (the negative impulse)

⚠ Now the input signal setting is flashing!

NOTE If the tachometer can't detect the signal (No RPM is displayed on the screen), you could choose another setting, and check it again.



- Press the **Select** button to enter the RPM setting screen.
- EX. The Impulse setting is changed from Lo to HI.



- EX. You want to change the bar graph tachometer range from 10,000 RPM to 15,000 RPM.
- Press the **Adjust** button to choose the range you want to set.
- EX. Now the current bar graph tachometer setting 10,000 RPM (10.0).

NOTE Setting range: 0~10,000 (10.0) / 15,000 (15.0) / 20,000 (20.0) RPM.

⚠ The digit you could set is flashing now.



- Press the **Select** button to enter the clock (Hours) setting screen.
- EX. Now the setting is changed from 10,000 RPM to 15,000 RPM.



- EX. To change the setting to 13:00.
- Press the **Adjust** button to choose the hour you want to set.
- EX. Now the setting is 0:00.

NOTE Setting range: 0~23 H.

⚠ The digit you could set is flashing now.



- Then press the **Select** button to enter the minute setting.
- EX. Now the setting is changed from 0:00 to 13:00.



- EX. To change the setting to 13:05.
- Press the **Adjust** button to select the minutes.
- EX. Now the setting is 13:00.

NOTE Setting range: 0~59 minutes.

⚠ The digit you could set is flashing now.



- Press the **Select** button to back to the main screen.
- EX. Now the setting is changed from 13:00 to 13:05.



- The main screen.

5 Trouble shooting

The following situation do not indicate malfunction of the meter. Please check the following before taking it in for repair.

Trouble	Check item	Trouble	Check item
The meter doesn't work when the power is on.	<ul style="list-style-type: none"> ● The power doesn't supply to the meter. → Please make sure the wiring is connected. The wiring and fuse are not broken. → The battery is broken or the battery is too old to supply enough power (DC 12V) to make the meter work. 	Temp does not appear or appear incorrectly. The clock is incorrect.	<ul style="list-style-type: none"> ● Please check the sensor. → Does the wiring break or falling off ? ● It is possible that the positive wire is connected wrongly. → Please check is the red positive wire connect to the permanent power or battery and the brown positive wire is connected to the key on switch positive pole.
The meter shows wrong information. Tachometer does not appear or appear incorrectly.	<ul style="list-style-type: none"> ● Please check the voltage of your battery, and make sure the voltage is over DC 12V. ● Please check the RPM sensor wiring is connected correctly. ● Please check the spark plug is R type or not. If not, please replace the spark plug with the R type spark plug. ● Please check your setting. → Please refer to the manual 4-2. 	The Max. record doesn't work, the meter setting is not recorded.	<ul style="list-style-type: none"> ● It is possible that the permanent power wire is not connected well. → Please check the red positive wire is connect well or not.

※If still can't solve the problems according to the steps above, please contact with distributors or us.